

MINI EXCAVATOR **SWE 20F**

Engine Power: **13.4 kW**

Machine Weight: **1840 kg–1940 kg**



OUR STANDARD FEATURES ARE OPTIONS FOR OTHERS

Presenting the SWE 20F

I take great pride in introducing the SWE 20F mini-excavator – specifically designed and certified for European market requirements. This 2 ton mini-excavator can do it all, either in professional hands or by occasional users. The machine's modern styling visualizes its durability and efficacy and indicates how easy the machine is to transport, operate and maintain.

This top-of-the-line mini-excavator offers excellent performance, comfortable and safe operation, and convenient maintenance. A product of our company's innovative DNA, the SWE 20F creates value for our customers and improves the quality of life.

In just 20 years, Sunward has grown to become one of the world's top 50 construction machinery manufacturers and top 20 excavator companies. Today, our products are exported to more than 100 countries worldwide.

Thank you for sharing our pride!

Professor He

Professor He

Main features

RELIABLE, POWERFUL AND DURABLE

We never compromise on reliability. And the 2 ton SWE 20F is no exception – we know it will be used by professional companies as well as rented to occasional users. So, just like our other machines, all key components come from the world's top premium brands. From the Yanmar Stage V engine to the Japanese-made hydraulic system, all is set for reliability, durability and enhanced performance. Sunward's unique hydraulic system enhances this 2 ton machine's performance by providing one of the more powerful bucket break-outs on the market.

VERSATILE AND OPTIMIZED

Because a 2 ton machine is essentially a multiple job site machine, it must be fit for all jobs and users' needs. The SWE 20F has 3 separate functional lines, which means that Sunward provides the highest flexibility on the market as standard, to accommodate any working requirement and tool.

SAFE AND COMFORTABLE

Because we know that safety and comfort should go hand-in-hand, the SWE 20F keeps you safe and provides every comfort in all working conditions. The fully EU-certified cab features FOPS and TOPS II, from the reinforced undercarriage to the boom and arm reinforced frames. And thanks to the full visibility provided by 4 perfectly positioned LED lights as a standard feature, you stay safe, day and night.

EASY TO MAINTAIN AND SERVICE

All Sunward machines are designed, prototyped and then disassembled – in the spirit of reverse engineering – simply to test how easy they are to be serviced and maintained. And they are! From ground-level access, to service components, to the availability of parts – maintaining the SWE 20F is easy and simple. So, it's no surprise that an operator only needs to try out our machines to be thoroughly convinced!



Reliable, Powerful and Durable

All key components are carefully selected

The powerful Yanmar 3 TNV 80F engine complies with the European Union's latest Stage V emission requirements and the EPA's Tier 4 final emission requirements. Plus, this engine features low fuel consumption, low noise and vibration levels, and high-altitude performance control.

The hydraulics are often regarded as the heart of the machine. That's why Sunward sources exclusively from the highest references in the market. For the SWE 20F, we selected Japanese premium brand NACHI to be our main supplier for the hydraulic pump and the traveling and swing motor. NACHI pumps and components for construction machinery are efficient, reliable, and space-saving. So, it's no coincidence that Sunward selected them to contribute to the SWE 20F's reliability.



 Max. 609 kg

Max. 1150 mm

Powerful lifting & digging forces and long reach capacity

The SWE 20F has exceptional digging forces of over 22.7 kN (bucket) and almost 10 kN (arm), which easily rival the 2-ton excavator competitors on the market. And when it comes to its long-reach digging capacity, the SWE 20F's boom cylinder design provides a reach that's over 1 meter (1150 mm) long.





SMOOTH OPERATIONS THANKS TO

Safety valve

Safety valves prevent uncontrolled cylinder movements, especially during the load lifting work. And because reliability and performance are part of the package, the SWE 20F is equipped with safety valves as a standard feature.

All of our 2 ton mini-excavators provide pilot traveling control as a standard feature – to continually enhance precise and controlled operations.

Premium brand critical components

<p>YANMAR Stage V engine</p>	<p>HYDROCONTROL Mechanical Cartridge Valves and joystick</p>	<p>NACHI Main pump</p>	<p>Traveling motor</p>	<p>Swing motor</p>
				

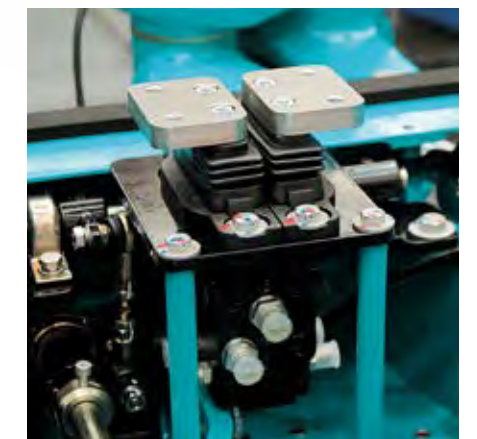

Auto gear shifting during traveling

The SWE 20F features auto high & low speed gear shifting in case the machine encounters an obstacle during high-speed traveling. To increase traction to get over the obstacle on a bumpy road, the SWE 20F shifts from high speed to low speed automatically. And then, after getting over the obstacle, the machine automatically returns to high-speed mode. This automatic gear shifting frees the operator from having to frequently flip the two-speed switch.

Boom and protection plates

An excavator's boom cylinders are particularly at risk of damage caused by flying stones when working in the field. We've taken special care to protect the boom and dozer cylinders with covering plates, so that the operator can focus fully on his job and not worry about the machine's components. And when you rent your machine, you know it will come back in good shape, ready for many more hours on the job.

Versatile and Optimized

Engineering and design produce optimal, versatile machines

In the spirit of Sunward's motto – 'Innovation Leads to Value' – all engineering and design are focused on generating optimal value for the machine buyer or owner. So, our machines can be used in a large variety of working conditions and applications – exactly what a 2 ton mini-excavator is expected to do.



Compact for easy transport all over the job sites

A 2 ton mini-excavator's versatility starts with how well it is designed for transportation. The SWE 20F does more than simply align with the EU's transportation regulations – truly compact (990 mm width) and lightweight (1840 kg), it allows easy, safe and secure transport. With automatic slew lock and 4 easily accessed tie-down points on the undercarriage, the machine can be safely transported on a small trailer with up to 3 buckets and a hydraulic breaker, while maintaining a total transport weight close to 2 ton.

Full auxiliary lines as standard

The SWE 20F can adapt to any job site, thanks to the complete auxiliary settings built in as standard – providing fully adjustable pressure and flow monitoring for all types of attachments.

This results in no less than 3 separate auxiliary lines as standard (while the market provides 1 to 2 lines as standard), which are distributed as follows:

- 1 line at the boom of the arm (AUX1), which is used primarily for the hydraulic quick-hitch
- 1 line for greater flow to fulfill the requirements of a flow-demanding attachment, such as a breaker (AUX2)
- 1 line with lesser flow as an extra line for attachments that are equipped with 2 actuators (AUX3)



2 auxiliary pipes

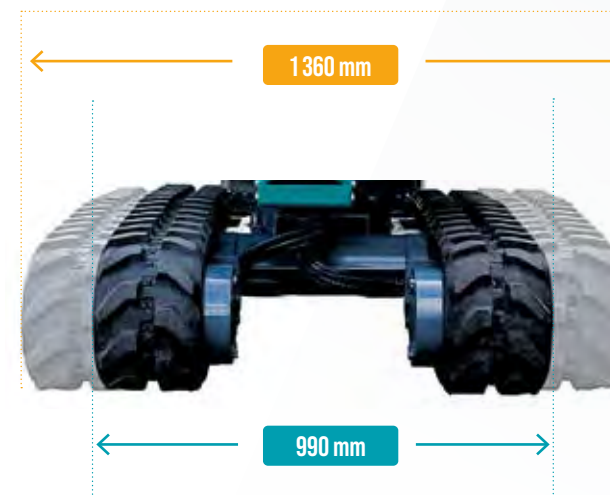

Flexible and stable

The SWE 20F's extendable undercarriage – the track width can be extended from 990 mm to 1360 mm – provides robust stability, ensuring safe and comfortable operation in all kinds of job applications.

STANDARD UNDERCARRIAGE
990 mm

EXTENDED UNDERCARRIAGE
1360 mm



Safe and Comfortable

On top of their EU certification, all Sunward machines on the European market are designed to meet European customer needs. And that includes no compromise between comfort and safety.



Safe & Comfy Cab

FOPS and TOPS II cab tops are standard and among the first features to ensure a safe and comfortable job in all application environments.

The large entrance to the roomy cab welcomes operators of all sizes from everywhere in Europe.

The well-organized cab is clearly designed to keep operators comfortable and productive.

From the suspension seat and heating, to the adjustable arm rest and the radio with USB ports, the cab's features promote efficiency.

The superior visibility through the large windows, and the simple layout of the controls, add to the great ease of operation. Finally, the safety pack – including fire extinguisher, safety hammer, and safety belt – contributes to overall peace of mind.

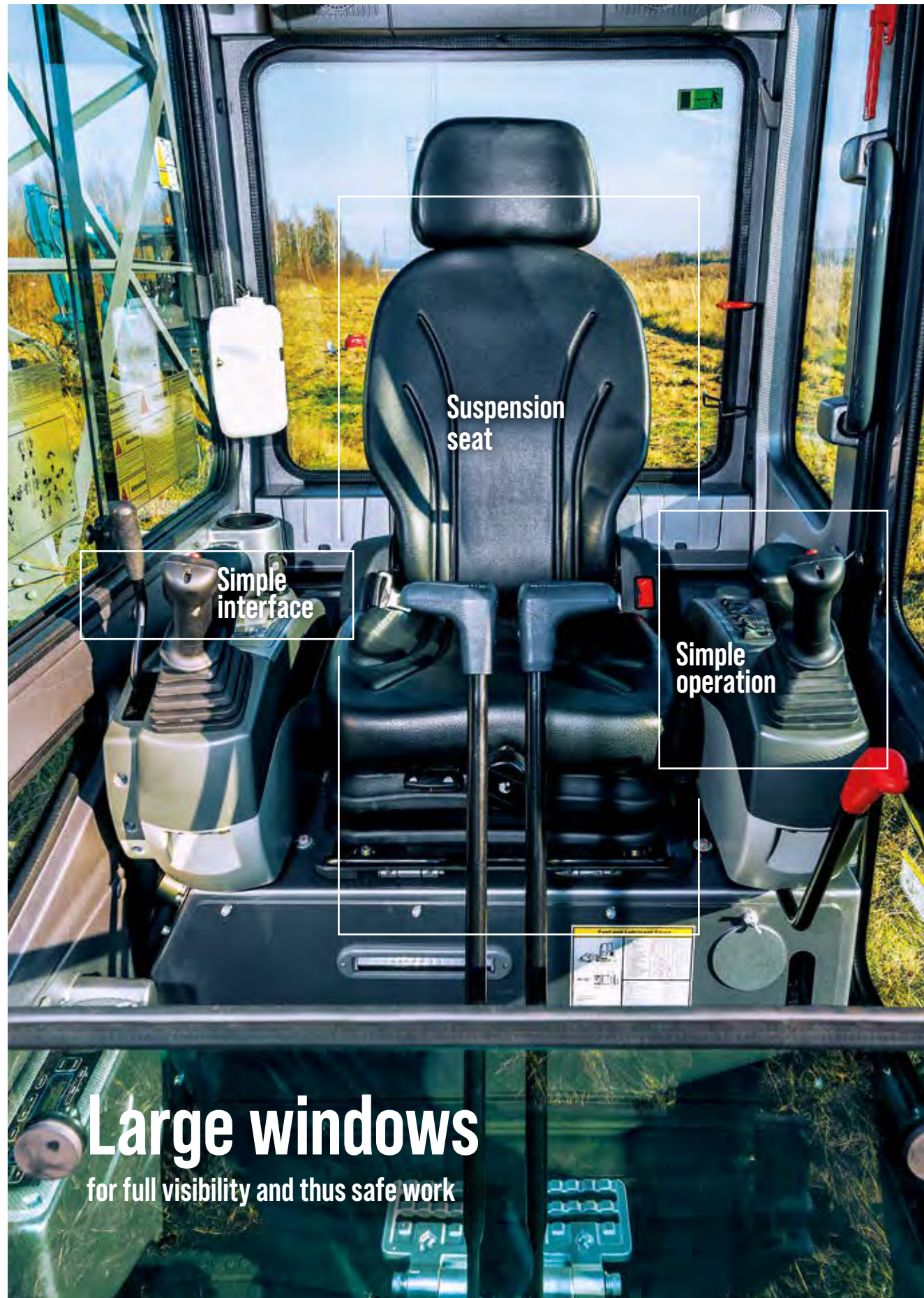

Suspension seat

Simple interface

Simple operation

Large windows
for full visibility and thus safe work

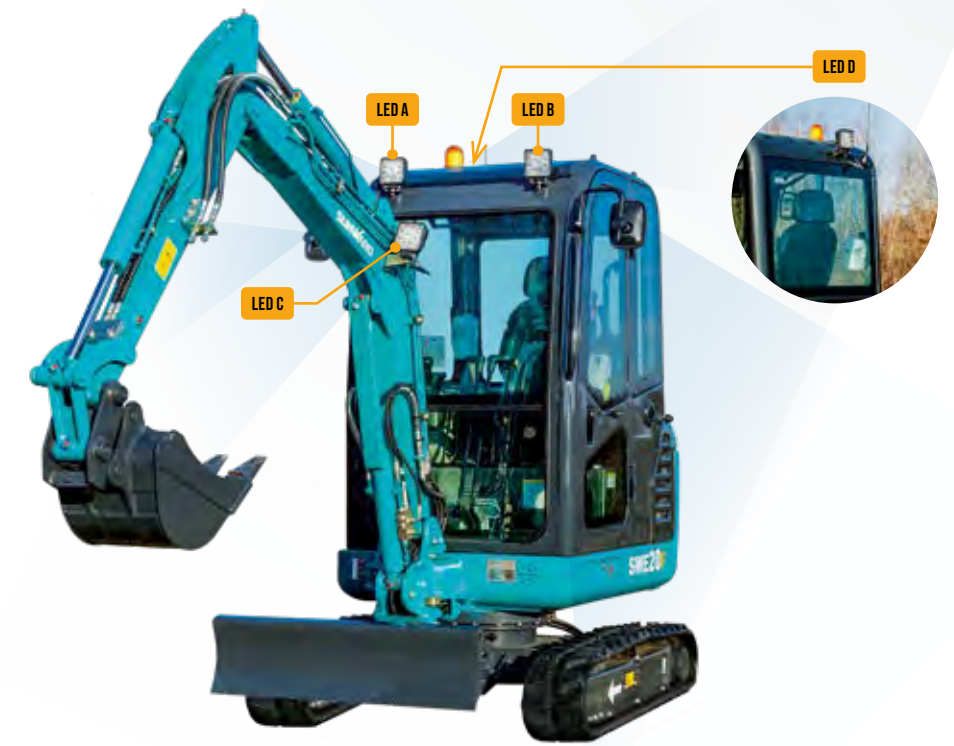

All-around visibility on bright and grey days

The cab's wide windows and slender frame, enhanced by mirrors on both sides, make it easy to operate with all-around awareness of the machine's environment. Plus, this 2 ton mini-excavator is equipped as standard with 4 LED lights – 2 on the front of the cab, 1 on the left side of the boom, and 1 on the rear of the cab – to keep working conditions safe in all kinds of weather, 24 hours a day.



Color monitoring screen

The easy-to-read 5.7" color monitoring screen, with centralized functions and simple interface for easy operation, makes all key information readily accessible: machine status, engine rpm and temperature, fuel level, machine hours, oil indicators and charging indications.

Easy to Maintain and Service

Centralized service points

To reduce maintenance time and cost, the covers at the rear and on the side provide direct access to the service points. With very easy access to the fuel tank and centralized grease fittings, the SWE 20F is as easy to maintain as it is to operate.

01 AIR FILTER

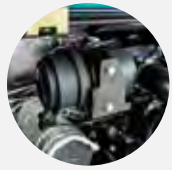

02 PILOT FILTER



03 EXPANSION TANK



04 INTERFACE FOR PRESSURE MEASUREMENT

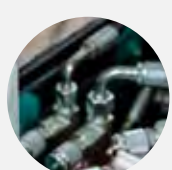

05 PRIMARY FUEL FILTER

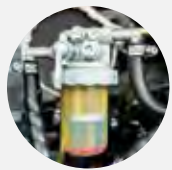

06 ELECTRIC FUEL SUCTION PUMP



07 FINE FUEL FILTER

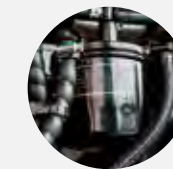

08 OIL LEVEL

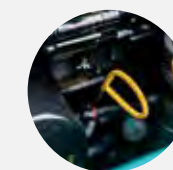

09 OIL FILLING PORT

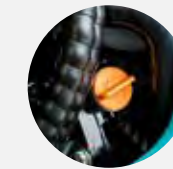

UP TO
3 YEARS
OF WARRANTY
STANDARD FOR ALL
SUNWARD PRODUCTS

Best Value for Money from A to Z

The SWE 20F's expert design includes a well-thought-out selection of components that streamline operation and maintenance. Our design choices result in a machine that provides so many standard features, premium-brand key components, and capabilities ... at a good price. And furthermore, Sunward's own genuine spare parts are economical as well – and all of this best value for money is crowned by a 3-year standard warranty.



Did you know?

Operators and maintenance teams can enjoy a machine that has been designed, prototyped and then disassembled – in the spirit of **reverse engineering** – to facilitate all service and maintenance operations.

Direct Support within Europe

Sunward's European headquarters are strategically located in Beringen, Belgium, in the heart of Europe: 45 minutes from Brussels International Airport and 60 minutes from the port of Antwerp.



Machines & Parts – Readily available

From its Beringen headquarters, Sunward Europe can ensure rapid delivery of machines and spare parts everywhere in Europe. Sunward machines and parts enjoy exceptional availability. Machines can be delivered very quickly from local dealers, and Sunward machine operators benefit from quick and easy access to a large parts distribution center in Beringen. Sunward Europe guarantees an availability rate of 95% for its spare parts.



PARTS CAN BE DELIVERED WITHIN 24 HOURS



Dealers all over Europe, UK and Middle-East

Dealers are at the heart of Sunward's passion for continuous improvement. Our dealers' knowledge is a real asset – their feedback from serving local market needs enhances our engineering and design innovations. Sunward's innovations create value – for machine operators and, ultimately, for our dealers.

Sunward provides Best Value for Money products to dealers and operators in a number of ways, especially through our Dealers' Parts Warehouse (DPW).

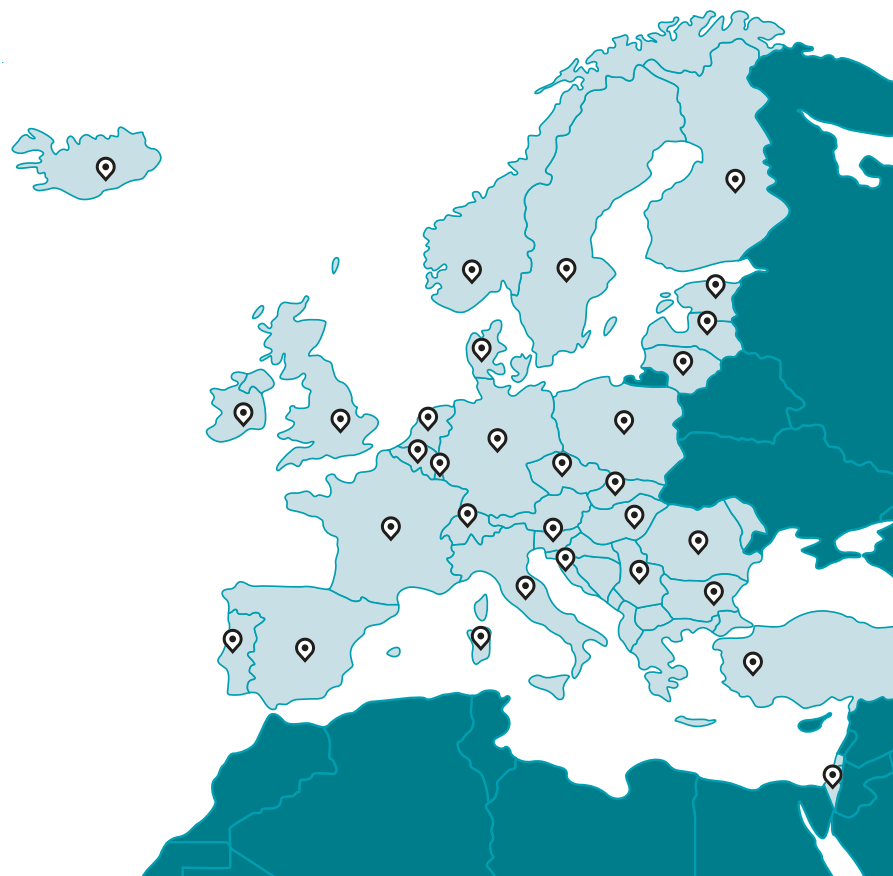

EQUIPMENT

The standard and optional equipment varies from country to country. For more information, please contact us.

		STANDARD EQUIPMENT	OPTIONAL EQUIPMENT
CAB	AM/FM radio	•	
	Cup holder	•	
	Seat with shock absorber	•	
	Warming System	•	
	Engine meso-position start system	•	
	Retractable harness	•	
	FOPS/TOPS cab	•	
	Windscreen washer and wiper	•	
	Rearview mirror	•	
	Cigarette lighter	•	
Travel alarm	•		
FRONT WORKING DEVICES	260 mm bucket		•
	380 mm bucket		•
	1 000 mm bucket		•
	1 150 mm arm	•	
	Breaker piping	•	
	Auxiliary piping	•	
TRACK	Hydraulic Quick Hitch piping	•	
	230 mm rubber track	•	
	230 mm steel track		•
	Expanded undercarriage	•	
ENGINE	Extendable blade	•	
	Oil filter	•	
	Fuel filter	•	
	Fuel-water separator	•	
	Air filter	•	
	Radiator	•	
	Alternator	•	
	Expansion tank	•	
	Electronic fuel pump	•	
	Muffler	•	
HYDRAULIC SYSTEM	Hydraulic pilot control	•	
	Parking-upon-swing brake	•	
	Parking-upon-traveling brake	•	
	Dual-speed traveling system	•	
	Automated gear shift system	•	
	Boom safety valve	•	
LIGHTS	6 auxiliary lines	•	
	Boom light	•	
	Front cab light	•	
	Warning light for closed cab version	•	
	Warning light for canopy version		•
Rear light	•		

TECHNICAL PARAMETERS

TYPE OF CAB		Cab/canopy
BUCKET CAPACITY		0.04 m ³
BUCKET WIDTH, STD.		380 mm
MACHINE WEIGHT		1 840–1 940 kg
DIMENSIONS	Overall dimension (L × W × H)	3 820 × 990 × 2 210 mm
ENGINE	Brand	YANMAR
	Model	3TNV80F-SSSU
	Emission rating	EU Stage V
	Displacement	1.267 L
	Output	13.4/2200 kW/rpm
TRACK	Type	Rubber track
	Rubber shoe width	230 mm
UNDERCARRIAGE	Track length	1 555 mm
	Length to center of rollers	1 210 mm
	Length to center of track	760/1 130 mm
	Traveling speed (High/Low)	3.5/2 km/h
	Gradeability	30 deg
SWING SPEED		10 rpm
GROUND PRESSURE		30 kpa
DOZER SIZE	Width	990/1 360 mm
	Height	267 mm
	Lifting capacity (Height/Depth)	295/360 mm
HYDRAULIC PUMPS	Type	2 variable plunger pumps, 1 gear pump, 1 pilot gear pump
	Flow rate	2*21+13.2+6 L/min
	Hydraulic pressure	21+16 MPa
SWING MOTOR		Plunger motor
TRAVEL MOTOR		2-speed plunger motor
FUEL TANK CAPACITY		23 L
HYDRAULIC OIL TANK CAPACITY		35 L

DIMENSIONS

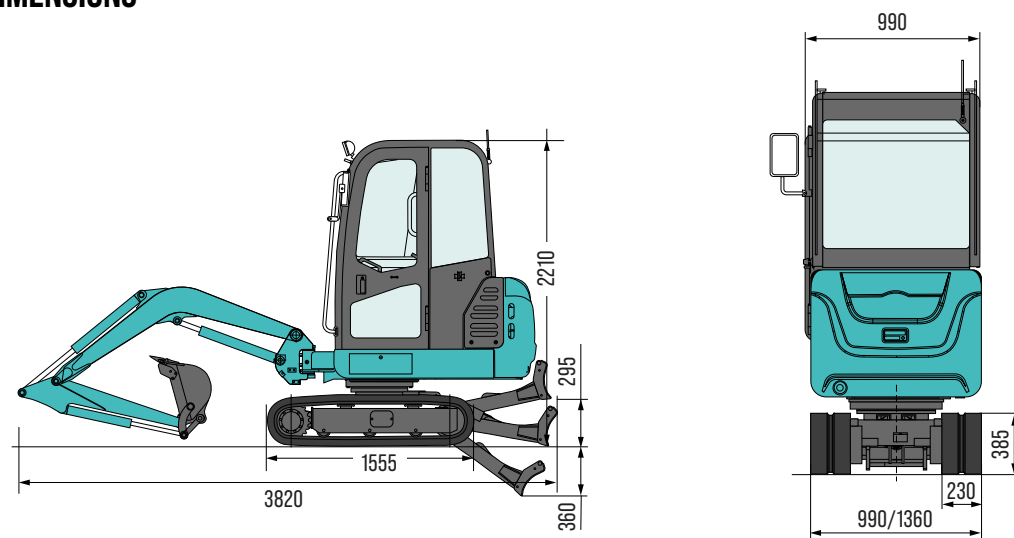

WORKING RANGE

WORKING RANGES	Max. cutting height	3 770 mm
	Max loading height	2 720 mm
	Max digging depth	2 380 mm
	Max digging reach	4 040 mm
	Boom swing angle (Left/Right)	75/50°
	Front swing radius	1 565 mm
	Tail swing radius	1 120 mm
	Max digging force (Arm)	9.83 kN
Max digging force (Bucket)	22.7 kN	

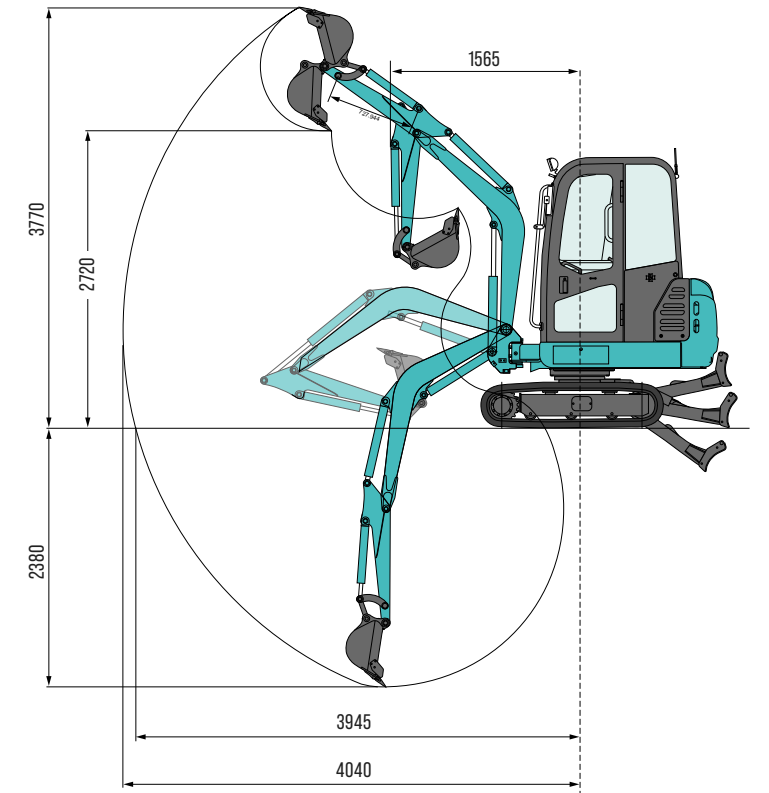

LIFTING CAPACITY

Lift Point Height (m)	Lift Point radius (MAX)		Lift Point radius (3.0 m)		Lift Point radius (2.0 m)	
	Over-front (kg)	Over-side (kg)	Over-front (kg)	Over-side (kg)	Over-front (kg)	Over-side (kg)
2.0	261.00*	265.40*	248.00*	256.70*	—	—
1.5	269.70*	274.10*	274.10*	278.40*	469.80*	478.50*
0	313.20*	313.20*	352.40*	356.70*	587.30*	587.30*
-1.0	326.30*	321.90*	—	—	465.5*	469.8*

Notes:

- Load with * is limited by hydraulic capacity and based on ISO 10567. Rated loads do not exceed 87% of hydraulic capacity.
- Load without * is limited by tipping load and based on ISO 10567. Rated loads do not exceed 75% of tipping capacity.
- A: distance from center of rotation to perpendicular of weight; B: distance between bucket hinge pin and ground level.

